

## New U-series compact network camera with enhanced functions and affordability

# Full HD Varifocal Lens Indoor Dome Network Camera

The new U series is an entry model that achieves high quality and reliability at an affordable price to meet the needs of a wide range of customers. The compact and slim design allows it to be installed in a various locations.

It newly supports ONVIF G / S / T profile and H.265 / H.264, and can be widely used for connecting various VMS and recorders. It also comes pre-installed with secure certificates, enabling device authentication and end-to-end communication encryption to counter the threat of advanced cyberattacks.

### Key features

- Compact and slim design allows installation in various locations
- Compliant with ONVIF G / S / T profile and H.265 / H.264, and can support a wide range of connections to VMS and recorders
- Uses "Easy Kitting Packing" that allows you to set the camera without removing it from the box
- Strengthen cyber security by pre-installing digital certificates issued by a third party organization (GlobalSign)

### Key i-PRO Spec.

- Full HD 1080p up to 30fps
- 2.5x built-in motorized zoom and motorized focus lens
- iA (intelligent Auto)
- Super Dynamic 120dB
- Color night vision (0.006 to 0.1 lx)
- H.265 Smart Coding
- Corridor mode  
(90 degrees or 270 degrees in image rotation)
- Built-in IR LED
- ONVIF Profile G / S / T

### Industry examples

- Retail
- Education
- Public safety
- Bank / Hospital / Building



# Specifications

<b>Camera</b>	Image Sensor	Approx. 1/3 type CMOS image sensor
	Minimum Illumination	Color : 0.1 lx, BW : 0.04 lx (50IRE, F2.0, Maximum shutter : Off (1/30s), AGC : 11) BW : 0 lx (50IRE, F2.0, Maximum shutter : Off (1/30 s), AGC : 11, when the IR LED is lit) Color : 0.006 lx, BW : 0.0025 lx (50IRE, F2.0, Maximum shutter : max. 16/30s, AGC : 11) *1
	White Balance	ATW1/ ATW2/ AWC
	Maximum shutter	<b>[30fps mode]</b> Max. 1/10000 s to Max. 16/30 s <b>[25fps mode]</b> Max. 1/10000 s to Max. 16/25 s
	Intelligent Auto	On / Off
	Super Dynamic	On / Off, The level can be set in the range of 0 to 31.
	Dynamic Range	Max.120 dB (Super Dynamic : On, Level: 31)
	Adaptive Black Stretch	—
	Back light compensation / High light compensation	BLC (Back light compensation) / HLC (High light compensation) / Off (only when Super dynamic / Intelligent Auto : Off)
	Fog compensation	On/ Off, The level can be set in the range of 0 to 8. (only when Intelligent auto / auto contrast adjust: Off)
	Maximum gain (AGC)	The level can be set in the range of 0 to 11.
	Color/BW (ICR)	Off / On (IR Light Off) / On (IR Light On) / Auto1 (IR Light Off) / Auto2 (IR Light On) / Auto3 (SCC)
	IR LED Light	High / Middle / Low / Off, Maximum irradiation distance : 30 m (Approx. 100 ft)
	Digital Noise Reduction	The level can be set in the range of 0 to 255.
	Video Motion Detection (VMD)	On / Off, 4 areas available
	Scene Change Detection(SCD)	On / Off, 1 areas available
	Privacy Zone	On / Off, Up to 8 zones available
	Image rotation*2	0° (Off) / 90° / 180° (Upside-down) / 270°
	Camera Title (OSD)	On / Off, Up to 20 characters (alphanumeric characters, marks)
	Focal length	2.9 mm - 7.3 mm(1/8inches-9/32inches)
Optical zoom	2.5x (Motorized zoom / Motorized focus)	
Extra optical zoom	2.5x - 3.8x (when resolution is 1280x720)	
Digital (electronic) zoom	Choose from 3 levels of x1, x2, x4	
Angular Field of View	<b>[16 : 9 mode]</b> Horizontal : 43° (TELE) - 100° (WIDE) Vertical : 24° (TELE) - 56° (WIDE) <b>[ 4 : 3 mode]</b> Horizontal : 36° (TELE) - 83° (WIDE) Vertical : 27° (TELE) - 62° (WIDE)	
Maximum Aperture Ratio	1 : 2.0 (WIDE) - 1 : 3.0 (TELE)	
Focusing Range	1 m (39-3/8 inches) - ∞	
<b>DORI</b>	Detect (25ppm / 8ppf)	Wide: 36.2 m / 118.7 ft, Tele: 98.5 m / 323.1 ft
	Observe (62.5ppm / 19ppf)	Wide: 14.5 m / 47.5 ft, Tele: 39.4 m / 129.2 ft
	Recognize (125ppm / 38ppf)	Wide: 7.2 m / 23.7 ft, Tele: 19.7 m / 64.6 ft
	Identify (250ppm / 76ppf)	Wide: 3.6 m / 11.9 ft, Tele: 9.8 m / 32.3 ft
<b>Adjusting Angle</b>		Horizontal (PAN) angle: ±180°, Vertical (TILT) angle: -30° - +85° Azimuth (YAW) angle: ±100°
<b>Browser GUI</b>	Camera Control	Brightness
	GUI / Setup Menu Language	English, Italian, French, German, Spanish, Portuguese, Russian, Chinese, Japanese
<b>Network</b>	Network IF	10Base-T / 100Base-TX, RJ45 connector
	Resolution	<b>[16 : 9 mode]</b> 1920×1080, 1280×720, 640×360, 320×180 <b>[ 4 : 3 mode]</b> 1600×1200, 1280×960, VGA, QVGA
	H.265/ H.264	Constant bit rate / VBR / Frame rate / Best effort
	H.264	Transmission Mode Unicast / Multicast
	H.264	Transmission Type Max. frame rate for each stream*3
JPEG	Image Quality	10 steps

<b>Network</b>	Smart Coding	<b>GOP(Group of pictures) control:</b> On(Frame rate control) / On(Advanced) / On(Mid) / On(Low) / Off *Frame rate control and Advanced are only available with H.265. <b>AUTO VIQS:</b> On/ Off	
	Audio Compression	—	
	Audio transmission mode	—	
	Supported Protocol	IPv6 : TCP/IP, UDP/IP, HTTP, HTTPS, SSL/TLS, SMTP, DNS, NTP, SNMPv1/v2/v3, DHCPv6, RTP, MLD, ICMP, ARP, IEEE 802.1X, DiffServ IPv4 : TCP/IP, UDP/IP, HTTP, HTTPS, SSL/TLS, RTSP, RTP, RTP/RTCP, SMTP, DHCP, DNS, DDNS, NTP, SNMPv1/v2/v3, UPnP, IGMP, ICMP, ARP, IEEE 802.1X, DiffServ	
	No. of Simultaneous Users	Up to 14 users (Depends on network conditions)	
	SDXC/SDHC/SD Memory Card (Option)	H.265/H.264 recording: Manual REC / Alarm REC (Pre/Post) / Schedule REC Available SDXC/SDHC/SD Memory Card : microSDXC memory card: 64 GB, 128 GB, 256 GB, 512 GB microSDHC memory card: 4 GB, 8 GB, 16 GB, 32 GB microSD memory card: 2 GB	
	Mobile Terminal Compatibility	iPad, iPhone, Android™ terminals	
	ONVIF Profile	G / S / T	
	<b>Alarm</b>	Alarm Source	VMD alarm, SCD alarm, Command alarm
		Alarm Actions	SDXC/SDHC/SD memory recording, E-mail notification, HTTP alarm notification Indication on browser, Panasonic alarm protocol output
<b>Input/ Output</b>	Monitor Output (for adjustment)	—	
	Audio input	—	
	Audio Output	—	
	External I/O Terminals	—	
<b>General</b>	Safety	UL (UL60950-1), c-UL (CSA C22.2 No.60950-1), CE, IEC60950-1	
	EMC	FCC (Part15 ClassA), ICES003 ClassA, EN55032 ClassB, EN55024	
	Power Source and Power Consumption	PoE (IEEE802.3af compliant) Device : DC48 V 120 mA, Approx. 5.8 W (Class 2 device)	
	Ambient Operating Temperature	-10 °C to +50 °C (+14 °F to +122 °F) {Power On range: 0 °C to +50 °C (+32 °F to +122 °F)}	
	Ambient Operating Humidity	10 to 90 % (no condensation)	
	Dimensions	ø129.5 mm x 101 mm (H) (ø5-3/32 inches x 3-31/32 inches (H)) Dome radius 40 mm (1-9/16 inches)	
	Mass (approx.)	Approx. 350 g (0.77 lbs)	
	Finish	Main body : ABS resin, i-PRO white Dome cover : acrylic resin, Clear	

\*1 Converted value

\*2 When "4:3(30fps mode)" or "4:3(25fps mode)" is selected for "Image capture mode", "90 °" and "270 °" cannot be selected.

\*3 Smart Coding(GOP and AUTO VIQS) is not available when setting 30fps.



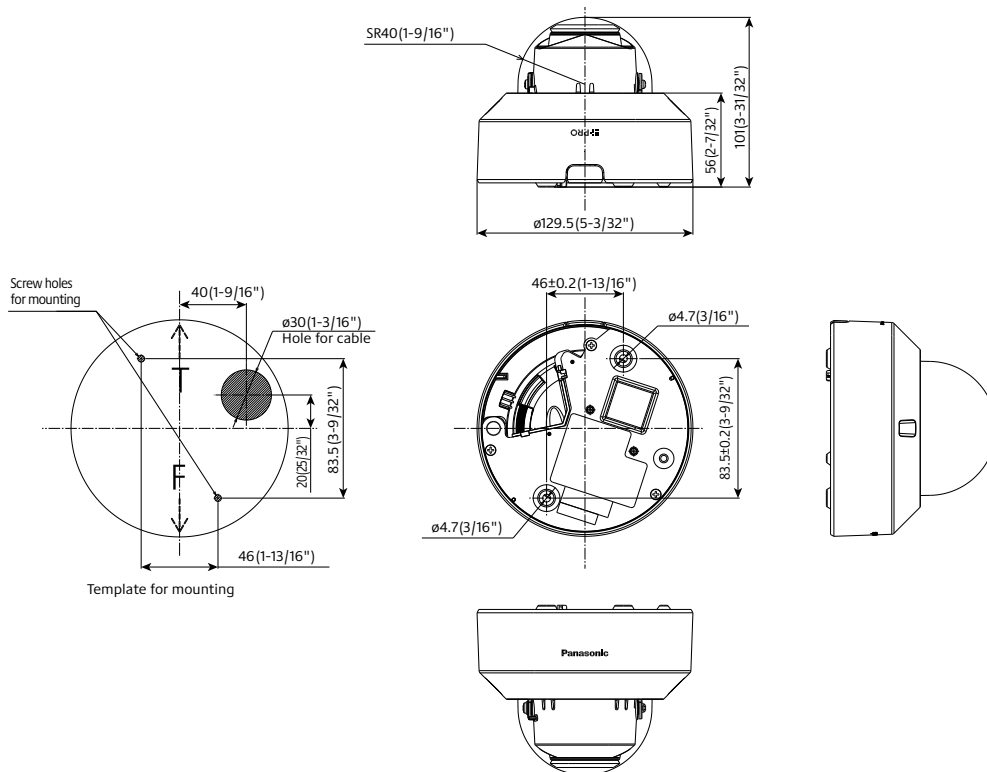









# Appearance







Unit : mm (inches)

## Optional Accessories

### Mount Bracket / Other

combination	WALL		POLE	CORNER	HANGING	
	1	2	1	1	1	2
	Wall Mount Bracket <b>WV-QWL501-W</b> (i-PRO white) 	Wall Mount Bracket <b>WV-QWL500-W</b> (i-PRO white) 	Pole Mount Bracket <b>WV-QPL500-W</b> (i-PRO white) 	Corner Mount Bracket <b>WV-QCN500-W</b> (i-PRO white) 	Ceiling Mount Bracket <b>WV-QCL501-W</b> (i-PRO white) 	Ceiling Mount Bracket <b>WV-QCL100-W</b> *1 (i-PRO white) 
Mount Bracket <b>WV-QSR501-W</b> (i-PRO white) 	Adapter Box <b>WV-QJB500-W</b> (i-PRO white)  *If needed.	Wall Mount Bracket <b>WV-QWL500-W</b> (i-PRO white) (+ <b>WV-QJB500-W</b> )  + 	Wall Mount Bracket <b>WV-QWL500-W</b> (i-PRO white) (+ <b>WV-QJB500-W</b> )  + 	Mount Bracket <b>WV-QSR501-W</b> (i-PRO white) 	3rd. parties pipe	

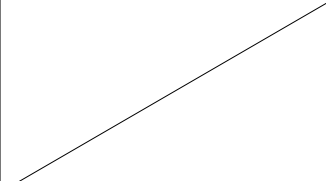
\*1 : It's possible to be used on the camera side and ceiling side. If used on both side, 2pieces are required.

combination	CEILING		OTHER
	1	2	1
	Ceiling Mount Bracket (Embedded) <b>WV-QEM100-W</b> (i-PRO white) 	Ceiling Mount Bracket <b>WV-Q105A</b> 	Attachment pipe (For 3rd party bracket) <b>WV-QAT500-W</b> (i-PRO white) 
		Mount Bracket <b>WV-QSR501-W</b> (i-PRO white) 	
		3rd. parties pipe	

### Dome Cover

Dome Cover (Smoke type)  
**WV-CF5SA**



#### Trademarks and registered trademarks

- iPad and iPhone are trademarks of Apple Inc., registered in the U.S. and other countries.
- Android is a trademark of Google LLC.
- ONVIF is trademarks or registered trademarks of Onvif Inc.
- All other trademarks identified herein are the property of their respective owners.

#### Important

- Safety Precautions : Carefully read the Basic Information, Installation Guide and Operating Instructions before using this product.
- Panasonic i-PRO Sensing Solutions Co., Ltd. cannot be held responsible for the performance of the network and/or other manufacturers' products used on the network.

• Masses and dimensions are approximate. • Specifications are subject to change without notice.

# Panasonic®

Panasonic Corporation

Panasonic i-PRO Sensing Solutions Co., Ltd.

<https://ipro.panasonic.com>

<https://security.panasonic.com>

<https://www.linkedin.com/company/i-pro-sensing-solutions-co-ltd/>

(2A-293A)