

Industry thinnest* multi-sensor cameras with AI Engine *the thinnest : i-PRO own research as of February 2022

4x6MP(25MP) IR Outdoor Multi-Sensor Network Camera with AI Engine

i-PRO releases 8 the industry thinnest multi-sensor cameras with AI Engine with lineup of 4MP/6MP/4K, 3eyes/4eyes with built-in IR LED. It is installed AI analytics applications which identify people and vehicles automatically, and users are able to start the latest surveillance technologies easily. It is designed to reduce installation time(thin and light weight) and continuous view assistance provides you 360/270-degree continuous images.

Key features

- The thinnest multi-sensor camera (3.5 inches/90 mm)
 - It can be fitted in not only outside, but it also is fitted in inside the facility.
 - (Low profile/Blends in seamlessly with environment)
 - Even though it is rated IK10, it achieves the light weight body.
- A variety kinds of AI Apps selection
 - It can install and use up to 4 different types of AI Apps all together. Using AI processor which identifies object as people or vehicle, it will reduce false alarm compared to conventional model. As result, it can be used many industries. Also, new multi-sensor has IR-LED function which will increase AI intruder detection accuracy in the low light environment.
- Easy installation
 - Just 1 LAN cable covers 4 directions.
 - Thin and hook architecture make easy installation
 - Continuous view assistance by using smartphone navigates you the best angle position.
 - You can change angle by using motorized zoom after installation.*4MP model only
- High security
 - New multi-sensor camera has equipped FIPS 140-2 level3 certified hardware to upgrade its security standard. Combining pre-installing digital certificates issued by a third party organization(Global Sign) and this, we can declare i-PRO high security level to those who cares cyber security.

Key i-PRO Spec.

- 4 x 6MP(25MP) 3328x1872 up to 15fps
- 360° coverage with one IP address
- Intelligent Auto (with AI Engine)
- Super Dynamic 120dB
- Color night vision (0.084 to 0.12 lx)
- Smart Coding (with AI Engine)
- Built-in 360° IR LED
- Continuous view assistance
- Wide range tilt angle adjustment mechanism
- ONVIF® Profile G / M / S / T
 - *ONVIF is a trademark of ONVIF, Inc.
- FIPS 140-2 level3 certified

Industry examples

- Public safety (City / Highway toll / Parking gate)
- Transportation (Airport / Train / Subway)
- Education
- Retail



WV-S8564L



WV-S8564LG



Specifications

Camera	Image Sensor	4x 1/2.8 type CMOS image sensor
	Minimum Illumination	Color : 0.084 lx (-G: 0.24 lx) (30IRE, F1.44, 1/30 s) ¹ Color : 0.12 lx (-G: 0.34 lx) (50IRE, F1.44, 1/30 s) BW : 0.05 lx (-G: 0.14 lx) (50IRE, F1.44, 1/30 s) BW : 0 lx (50IRE, F1.44, 1/30 s with IR LED)
	White Balance	ATW1 / ATW2 / AWC
	Maximum shutter	15 fps mode: Max.1/10000s to Max.16/30s 12.5 fps mode: Max.1/10000s to Max.16/25s
	Intelligent Auto	On / Off
	Super Dynamic	On / Off, The level can be set in the range of 0 to 31.
	Dynamic Range	Max.120 dB (Super Dynamic : On, Level 31)
	Adaptive Black Stretch	The level can be set in the range of 0 to 255.
	Back light compensation / High light compensation	BLC (Back light compensation) / HLC (High light compensation) / Off (only when Super dynamic / Intelligent Auto : Off)
	Fog compensation	On / Off (only when Intelligent auto / auto contrast adjust : Off)
	Maximum gain (AGC)	The level can be set in the range of 0 to 11.
	Color/BW (ICR)	Off / On(IR Light Off) / On(IR Light On) / Auto1(IR Light Off) / Auto2(IR Light On) / Auto3(SCC)
	IR LED Light	High / Middle / Low / Off Maximum irradiation distance : 40 m (Approx. 131 ft) / (-G): 30 m (Approx. 99 ft) (30IRE) ¹ 30 m (Approx. 99 ft) / (-G): 21 m (Approx. 69 ft) (50IRE)
	Digital Noise Reduction	The level can be set in the range of 0 to 255.
	Panorama	Panorama mode (H: 180 deg.)
	Video Motion Detection (VMD)	On / Off, 4 areas available
	Scene Change Detection (SCD)	On / Off, 1 areas available
	Audio Detection	On / Off
	AI Sound Classification	Selectable from Gunshot, Yell, Vehicle horn, Glass break
	AI Analytics	Yes
	Privacy Zone	On / Off, Up to 8 zones available
	VIQS	On / Off, Up to 8 zones available
	Image rotation ²	0° (Off) / 90° / 180° (Upside-down) / 270°
	Camera Title (OSD)	On / Off, Up to 40 characters, Up to 2 Lines (alphanumeric characters, marks)
	Focus Adjustment	—
Lens	Optical zoom	1x
	Extra zoom	max 5x (when resolution is 640x360)
	Focal length	3.1 mm (1/8 inches)
	Angular Field of View	Horizontal : 108°, Vertical : 56°
	Maximum Aperture Ratio	1 : 1.4
DORI	Detect (25ppm / 8ppf)	56.8 m / 186.4 ft
	Observe (62.5ppm / 19ppf)	22.7 m / 74.6 ft
	Recognize (125ppm / 38ppf)	11.4 m / 37.3 ft
	Identify (250ppm / 76ppf)	5.7 m / 18.6 ft
System on Chip (SoC)	Ambarella CV2	
Adjusting Angle	Camera 1, 2, 3, 4 :	Horizontal : ±125° (Adjust by horizontal (PAN) angle) Vertical : +10° to +105° (Adjust by vertical (TILT) angle) Yaw : +90° (Adjust by azimuth (YAW) angle) Twist : ±30°
	*The above is the adjustable range of a single camera. The adjustable range of each camera varies according to the positional relationship with other cameras.	
Browser GUI	Camera Control	Brightness, AUX On / Off
	Audio	Mic (Line) Input : On / Off Volume adjustment : Low / Middle / High Audio Output : On / Off Volume adjustment : Low / Middle / High
	GUI / Setup Menu Language Browser ³	English, Italian, French, German, Spanish, Portuguese, Russian, Chinese, Japanese Microsoft Edge, Firefox, Google Chrome
Network	Network IF	10Base-T / 100Base-TX / 1000Base-T, RJ45 connector
	Resolution	[16 : 9 mode] 3328x1872 / 2560x1440 / 1920x1080 / 1280x720 / 640x360 / 320x180
	H.265 / H.264 / JPEG (MJPEG)	Constant bit rate / VBR / Frame rate / Best effort
	H.264 ⁴ / JPEG	Unicast port (AUTO) / Unicast port (MANUAL) / Multicast Image Quality 10 steps

Network	Smart Coding	GOP (Group of pictures) control : On (Frame rate control) * / On (Advanced) * / On (Mid) / On (Low) / Off * *On (Frame rate control) and On (Advanced) are only available with H.265. Smart VQS: On(High)/On(Low)/Off, Smart P-picture control: On/Off
	Audio Compression	G.726 (ADPCM) : 16 kbps / 32 kbps G.711 : 64 kbps AAC-LC ⁵ : 64 kbps / 96 kbps / 128 kbps
	Audio transmission mode	Off / Mic (Line) input / Audio output / Interactive (Half duplex) / Interactive (Full duplex)
	Supported Protocol	IPv6 : TCP/IP, UDP/IP, HTTP, HTTPS, SSL/TLS, SMTP, DNS, NTP, SNMPv1/v2/v3, DHCPv6, RTP, MLD, ICMP, ARP, IEEE 802.1X, DiffServ, LLDP, MQTT IPv4 : TCP/IP, UDP/IP, HTTP, HTTPS, SSL/TLS, RTP, RTSP, RTCP, SMTP, DHCP, DNS, DDNS, NTP, SNMPv1/v2/v3, UPnP, IGMP, ICMP, ARP, IEEE 802.1X, DiffServ, SRTP, LLDP, MQTT
	No. of Simultaneous Users	Up to 24 users (Depends on network conditions)
	Secure	FIPS 140-2 level3
	SDXC/SDHC/SD Memory Card	H.265 / H.264 recording : Manual REC / Alarm REC (Pre/Post) / Schedule REC / Backup upon network failure JPEG recording : Manual REC / Alarm REC (Pre/Post) / Backup upon network failure Compatible SDXC/SDHC/SD Memory Card : microSDXC memory card : 64 GB, 128 GB, 256 GB, 512 GB microSDHC memory card : 4 GB, 8 GB, 16 GB, 32 GB microSD memory card : 2 GB
	Mobile Terminal Compatibility	iPad, iPhone, Android™ terminals
	ONVIF® Profile	G / M / S / T
	Alarm	Alarm Source
Alarm Actions		SDXC/SDHC/SD memory recording, E-mail notification, HTTP alarm notification indication on browser, TCP alarm notification output
Input/ Output	Monitor Output (for adjustment)	—
	Audio input ⁶	ø3.5 mm stereo mini jack For microphone input : Recommended applicable microphone : Plug-in power type (Sensitivity of microphone : -48 dB±3 dB (0 dB=1 V/Pa, 1 kHz)) Input impedance : Approx. 2 kΩ (unbalanced) Supply voltage : 2.4 V ±0.5 V For line input : Input level : Approx. -10 dBV
	Audio Output ⁶	ø3.5 mm stereo mini jack (monaural output) Output impedance : Approx. 600 Ω (unbalanced) Output level : -20 dBV
	External I/O Terminals ⁶	ALARM IN 1 (Alarm input 1/ Black & white input/ Auto time adjustment input) (x1) ALARM IN 2 (Alarm input 2/ ALARM OUT) (x1), ALARM IN 3 (Alarm input 3/ ALARM OUT/ ALARM OUT) (x1)
General	Safety	UL (UL62368-1), c-UL (CSA C22.2 No.62368-1), CE, IEC62368-1
	EMC	FCC (Part15 ClassA), ICES-003 ClassA, EN55032 ClassA, EN55024
	Power Source and Power Consumption	PoE+ (IEEE802.3at compliant): DC 54 V: 470 mA/Approx. 25.4 W (Class 4 device)
	Ambient Operating Temperature	-40 °C to +60 °C ⁷ {-40 °F to 140 °F} (Power On range: -20 °C to +60 °C {-4 °F to 140 °F}) Maximum temperature according to NEMA TS 2 (2.2.7): 74 °C (165 °F)
	Ambient Operating Humidity	10 to 100 % (no condensation)
	Anti-Condensation System	Temish element + moisture absorption gel
	Water and Dust Resistance	IP67/IP66 (IEC 60529), Type 4X (UL50E), NEMA 4X compliant
	Shock Resistance	IK10 (IEC62262)
	Other standard support	NEMA TS 2 (2.2.7-2.2.9)
	Dimensions	When using the attachment plate only : ø300 mm × 90 mm (H) {ø11-13/16 inches × 3-17/32 inches (H)}
Mass (approx.)	When using the attachment plate only : Approx. 3.3 kg (7.28 lbs)	
Finish	Main body : Aluminum die cast, i-PRO white Outer fixing screws : Stainless steel (Corrosion-resistant treatment) Dome cover : PC resin, Clear PC resin, Smoke (G)	

¹ Converted value

² When the 320x180 resolution is used, the "90°" and "270°" settings are not available.

³ For information on the operation verification of the supported web browsers, refer to our support website <Control No.: C0132>.

⁴ Transmission for each stream can be individually set.

⁵ When recording audio on a microSD memory card, only use AAC-LC (Advanced Audio Coding - Low Complexity).

⁶ When using with these, WV-QCA501A cable is required.

⁷ When using with the IR LED light constantly lit, the upper limit of the operating temperature range is +50 °C (+122 °F).

Appearance

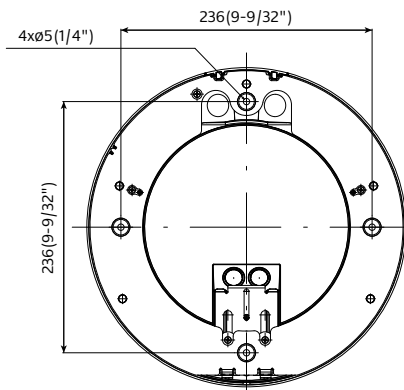
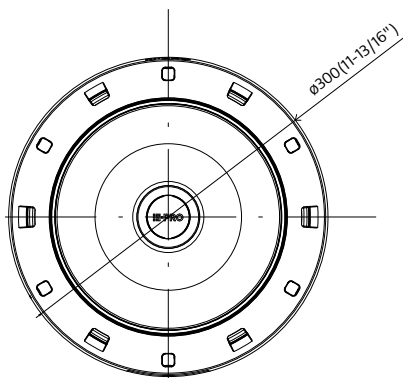
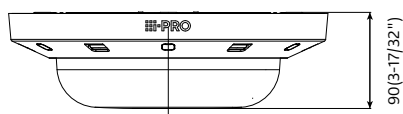

Unit : mm (inches)

AI Analytics applications

<https://i-pro.com/global/en/surveillance/products/i-pro-ai-application>

AI Video Motion Detection (AI-VMD)

Advanced video analysis technology detects objects (faces, people, cars, motorcycles) in a specified area. (Intruder Detection, Loitering Detection, Direction Detection, Cross Line Detection)

AI Face Detection

Detects faces with high precision even in low-light, backlit, and mask-wearing environments. (Max. 2 cameras working)

AI People Detection

Extract the characteristics of human face / clothing and classify them into meaningful categories such as gender, age, and clothing color.

AI Vehicle Detection

Extract vehicle characteristics and classify them into meaningful categories such as type and color.

AI Non mask Detection

Deep-learning and proprietary image processing technologies recognize mask and detect people who are not wearing them.

AI Occupancy Detection

















Detecting the congestion via network camera with AI engine enables that information to be used direct visitors in advance or help store staff work more efficiently.

3rd party applications are also available.



<https://i-pro.com/global/en/surveillance/i-pro-application-platform/application-list>

Optional Accessories

Mount Bracket / Other

	WALL		POLE		CORNER		HANGING			CEILING	
	1	1	1	1	1	1	2	3	1	2	
combination	Wall Mount Bracket WV-QWL501-W (i-PRO white) 	Pole Mount Bracket WV-QPL500-W (i-PRO white) 	Corner Mount Bracket WV-QCN500-W (i-PRO white) 	Ceiling Mount Bracket WV-QCL501-W (i-PRO white) 	Ceiling Mount Bracket WV-QCL100-W (i-PRO white)  *For indoor installation only.	Ceiling Mount Bracket WV-QCL100-W*1 (i-PRO white)  *For indoor installation only.	Base Bracket WV-QJB503-W (i-PRO white)  *The actual product may differ.	Ceiling Mount Bracket WV-Q105A (Silver)  *For indoor installation only.			
	Mount Bracket WV-QSR503-W (i-PRO white) 	Wall Mount Bracket WV-QWL501-W (i-PRO white) 	Wall Mount Bracket WV-QWL501-W (i-PRO white) 	Mount Bracket WV-QSR503-W (i-PRO white) 	Mount Bracket WV-QSR503M-W (i-PRO white, ISO Male thread) 	3rd Party Pipe (i-PRO white, ISO Male thread)		Base Bracket WV-QJB503-W (i-PRO white)  *The actual product may differ.			
		Mount Bracket WV-QSR503-W (i-PRO white) 	Mount Bracket WV-QSR503-W (i-PRO white) 			Mount Bracket WV-QSR503F-W (i-PRO white, ISO Female thread) 					

*1: It's possible to be used on the camera side and ceiling side. If used on both side, 2pieces are required.

OTHER	
combination	1 3rd Party Pipe (Male or Female thread)
	Mount Bracket WV-QSR503F-W (i-PRO white, ISO Female thread) 
	Mount Bracket WV-QSR503M-W (i-PRO white, ISO Male thread) 

Dome Cover

Smoke dome cover
WV-QDC501G

Cable

I/O Cable
WV-QCA501A
WV-QCA501APK



*WV-QCA501APK is package of 10 cables.

*The color of the grommet rubber may differ depending on the production time, but the performance and mounting method will not change.

Trademarks and registered trademarks

- iPad and iPhone are trademarks of Apple Inc., registered in the U.S. and other countries.
- Android is a trademark of Google LLC.
- ONVIF is a trademark of ONVIF, Inc.
- All other trademarks identified herein are the property of their respective owners.

Important

- Safety Precautions : Carefully read the Basic Information, Installation Guide and Operating Instructions before using this product.
- i-PRO Co., Ltd. cannot be held responsible for the performance of the network and/or other manufacturers' products used on the network.

• Masses and dimensions are approximate. • Specifications are subject to change without notice.